

OR DRAPE CATALOGUE

OR DRAPE RANGE

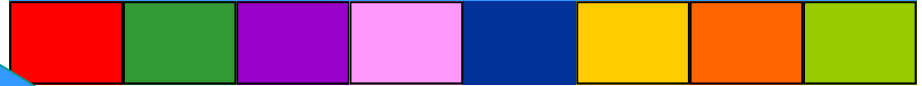

OR DRAPE RANGE



Terminology

MATERIAL SPECIFICATIONS

SMMS—Spunbonded Polypropylene, Meltblown, Meltblown, Spunbond Polypropylene (SMMS) fabric consists of four layers of non woven material. The layers are bonded so the material appears single ply; this bonding gives the material extra strength and repellency therefore reducing the risk of bacteria entering the wound site.

SMMS fabric is fluid repellent and has a high hydrostatic head to give exceptional strikethrough protection against water, blood and other bodily fluids. SMMS is low linting, minimising the risk of wound contamination. The strength of the material is obtained from the spunbond polypropylene and the repellency from the meltblown. SMMS fabric allows fluid control and protection whilst still providing patient comfort.

The absorbent panel has a lock away core that is hydrophylically treated which allows high Absorbency

SMS - Spunbonded Polypropylene, Meltblown, Spunbond Polypropylene (SMS) is a non woven fluid repellent fabric. It has similar properties to SMMS, however it has only three layers as opposed to the four of SMMS.

Laminate - This draping material consists of two or three layer laminate, which gives total impermeability over the entire surface. Laminated materials have a PE layer so the drape is impervious. Fluid absorbs into the top layer (spunbond material treated to make the material absorbent) but cannot strike through because of the totally fluid proof PE film. There is a soft base layer that provides comfort for the patient.

Cotton - fabric woven from cotton fibres

PE - Polyethylene (PE) - a plastic layer which is either clear or coloured in our drape portfolio

2 ply – 2 materials bonded together – in the case of the 365 drapes 1 layer is always plastic (PE) to prevent infection

3 ply – 3 layers of material bonded together – in the case of the 365 drapes the middle layer is always plastic (PE) to provide a total barrier and prevent infection.

EFF - Poly Spun Lace – Is a material made from wood pulp polyester. With a texture similar to that of linen, chosen for softness and flexibility of movement. Whilst offering excellent barrier protection, maintaining low heat generation and offering more comfort than other impervious gowns.

Glossary of terms

Absorbent reinforced panel - zoned area around critical operating site to provide extra absorbency and strength

Adhesive edged - a sticky taped edge running down one edge of a drape. The adhesive is used to secure the drape in place during the procedure and is usually fixed to the patient

Aperture - access hole in drape enabling entry to the operating area

Sterile field - a wrap around the product to stop contamination when items are removed from packaging

Tape strip - non woven material backed with adhesive



An absorbent reinforced panel

All measurements of drapes are given in the order of width (cm) and then length (cm).

The fenestration size given in this drape catalogue is the total size of the aperture on the drape. Included in the measurement is the incise (adhesive film around and within the fenestration).



OR DRAPE RANGE

Contents

Speciality:	Page No:	Speciality:	Page No:
General Surgery	5 - 9	Gynaecology & Obstetrics	19 - 21
Universal Set Standard	6	Gyn/Cystoscopy Set	20
Universal Set Reinforced	6	Caesarean Section Set with incise	20
Universal Set with Mayo Cover	6	Caesarean Section Set with fenestration	21
Laparoscopy Set	7	Lithotomy Set	21
Universal Laparoscopy Pelviscopy Set	7	Urology	22 - 23
Incise Drapes	8	TUR Set	23
Orthopaedic	9 - 15	ENT/Head & Neck/Neuro	24 - 26
Hip Set Basic	10	Craniotomy Set	25
Hip Set Intermediate	10	Head and Neck Drape	23
Hip Set Advanced	10	Basic Head and Neck Set	23
Hip Set Elliptical	11	ENT Drape Set	24
Extremity Set	11	ENT Split Set without Mayo	24
Knee Arthroscopy Set	11	Supplementaries	27 - 32
Vertical Isolation drape	12	Utility Drapes	28
Hand Drape	12	Trolley Covers	28
Bi Lateral Knee Arthroscopy	12	Adhesive Drapes	29
Foot Drape	13	Aperture Drapes	30
Beach Chair Shoulder Drape	13	Mayo Covers	30
Bi-lateral Limb Sheet	13	Split sheets	30
Tourniquet Drape	14	Lithotomy Leggings	31
Extremity Foot cover	14	Stockinette	31
Vertical Isolation Drape	14	Miscellaneous	32
Beach Chair Shoulder drape with Patient Safety Window	15	Under Buttock Drapes	32
Cardiovascular	16 - 18		
Cardiovascular Set	17		
Lower Vascular Drape	17		
EVAR Drape	18		



OR DRAPES

365 Healthcare Ltd is an innovative and exciting company, committed to operational excellence. Our focus ensures the provision of unrivalled customer care and excellent on-going product support with solution driven initiatives. We are pleased to present our latest range of surgical drapes available through the NHS Supply Chain.

The drapes range from 365 Healthcare is unique, and designed for single use surgical drapes from offering enhanced absorbency for improved protection.

The range covers a wide variety of surgical procedures offering a complete impermeable draping solution for patient protection.

Comprehensive draping packs are available in addition to a full range of supplementary products.

General Surgery

Orthopaedic

Cardiovascular

Gynaecology & Obstetrics

ENT/Head & Neck/Neuro

Urology

Ophthalmology

Supplementaries

OR DRAPES

General Surgery

Universal Set Standard

Universal Set Reinforced

Universal Set with Mayo Cover

Laparoscopy Set

Universal Laparoscopy Pelviscopy Drape Pack

Universal Set Standard

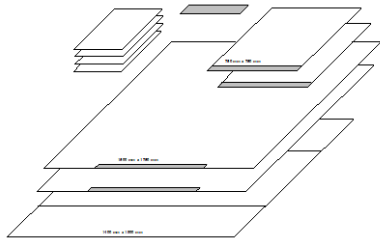

Sterile Code	Description	Size (width x Length)	Base Material
36581001	Universal Set Standard	-	-
-	2 x Adhesive edged drapes	150cm x 175cm	3 ply laminate
-	2 x Adhesive edged drapes	75cm x 75cm	3 ply laminate
-	4 x Hand Towels	-	-
-	1 x Tape Strip	10cm x 50cm	-
-	1 x Zone reinforced trolley cover	140cm x 190cm	Polyethylene with 66 x 190cm absorbent area

36581001

Universal Set Reinforced

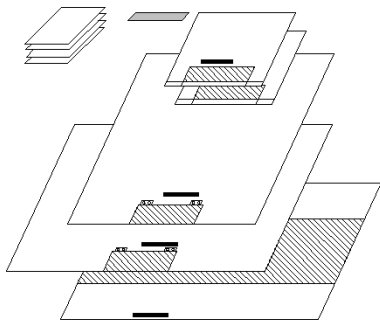

Sterile Code	Description	Size (width x Length)	Base Material
36581002	Universal Set Reinforced	-	-
-	1 x Reinforced adhesive edged drape	150cm x 240cm	3 ply laminate
-	1 x Reinforced adhesive edged drape	175cm x 175cm	3 ply laminate
-	2 x Reinforced adhesive edged drapes	75cm x 90cm	3 ply laminate
-	4 x Hand Towels	-	-
-	1 x Tape Strip	10cm x 50cm	-
-	1 x Zone reinforced trolley cover (used as sterile field)	140cm x 190cm	Polyethylene with absorbent area 66 x 190cm

36581002

Universal Set Reinforced with Mayo

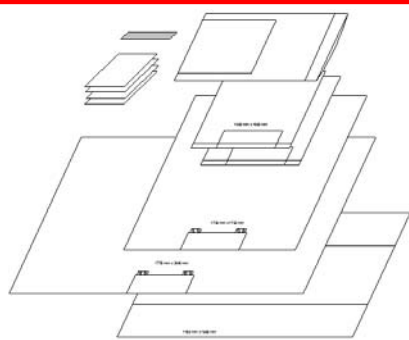

Sterile Code	Description	Size (width x Length)	Base Material
36581003	Universal Set Reinforced	-	-
-	1 x Reinforced adhesive edged drape	175cm x 175cm	3 ply laminate
-	1 x Reinforced adhesive edged drape	175cm x 300cm	3 ply laminate
-	2 x Reinforced adhesive edged drapes	100cm x 100cm	3 ply laminate
-	4 x Hand Towels	-	-
-	1 x Tape Strip	10cm x 50cm	-
-	1 x Mayo cover reinforced	76cm x 145cm	Polyethylene and reinforced area
-	1 x Zone reinforced trolley cover (used as sterile field)	140cm x 190cm	Polyethylene with absorbent area 66 x 190cm

36581003

Laparoscopy Set

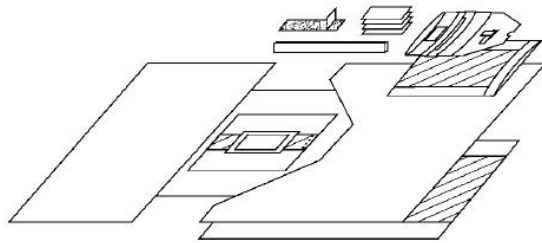

Sterile Code	Description	Size (width x Length)	Base Material
36581004	Laparoscopy Set	-	-
-	1 x Laparoscopy drape	260cm x 260cm	3 ply laminate
-	1 x Camera cover	12cm x 240cm	Polyethylene
-	1 x Velcro strip/tube holder	-	-
-	4 x Hand Towels	-	-
-	1 x Tape Strip	10cm x 50cm	-
-	1 x Mayo cover reinforced	76cm x 145cm	-
-	1 x Zone reinforced trolley cover	140cm x 190cm	Polyethethylene with 66 x 190cm absorbent area

36581004

Universal Laparoscopy Pelviscopy

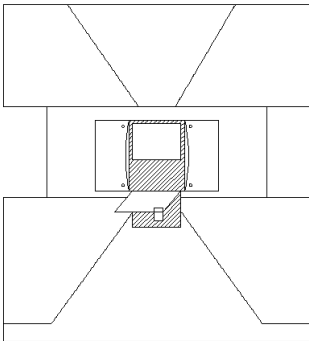

Sterile Code	Description	Size (width x Length)	Base Material
36581008	Universal Laparoscopy Drape	-	-
-	1 x Universal Laparoscopy drape	255cm x 280cm	3 ply laminate
-	2 x Tape Strips	10cm x 50cm	-
-	1 x Zone reinforced trolley cover (used as sterile field)	140cm x 190cm	Polyethethylene with absorbent area 66 x 190cm

36581008

Incise drape

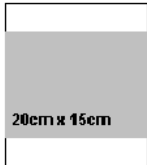

20cm x 15cm
20cm x 23cm

Sterile Code	Description	Size (width x Length)	Adhesive Area
36588002	Incise Drape	20cm x 23cm	20 x 15cm

36588002

Incise drape

Sterile Code	Description	Size (width x Length)	Adhesive Area
36588010	Incise Drape	45cm x 68cm	45 x 60cm

36588010

Incise drape

Sterile Code	Description	Size (width x Length)	Adhesive Area
36588005	Incise Drape	90cm x 68cm	90 x 60cm

36588005

Incise drape

Sterile Code	Description	Size (width x Length)	Adhesive Area
36588014	Incise Drape	40cm x 43cm	40 x 35cm

36588014

Incise drape



30cm x 25cm
30cm x 33cm

Sterile Code	Description	Size (width x Length)	Adhesive Area
36588008	Incise Drape	30cm x 33cm	30 x 25cm

36588008

Incise drape

Sterile Code	Description	Size (width x length)	Adhesive Area
36588015	Incise Drape	45cm x 60cm	45 x 50cm

36588015

Incise drape



35cm x 35cm
35cm x 43cm

Sterile Code	Description	Size (width x Length)	Adhesive Area
36588009	Incise Drape	35cm x 43cm	35 x 35cm

36588009

Incise drape

Sterile Code	Description	Size (width x Length)	Adhesive Area
36588017	Incise Drape	85cm x 68cm	85 x 60cm

36588017

OR DRAPES

Orthopaedic

Hip Set Standard

Hip Set Intermediate

Hip Set Advanced

Hip Set Elliptical

Extremity Set

Knee Arthroscopy Set

Vertical Isolation Set

Hand Drape

Foot Drape

Beach Chair Shoulder Drape

Hip Set Standard

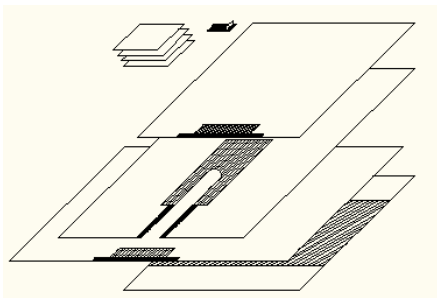

Sterile Code	Description	Size (width x Length)	Base Material
36582001	Hip Set Standard	-	-
-	1 x Reinforced adhesive edged drape	175cm x 300cm	3 ply laminate
-	1 x Reinforced adhesive edged drape	175cm x 175cm	3 ply laminate
-	1 x Reinforced split sheet	200cm x 260cm	3 ply laminate with reinforced area
-	4 x Hand Towels	-	-
-	1 x Tape Strip	10cm x 50cm	-
-	1 x Zone reinforced trolley cover	140cm x 190cm	Polyetheylene with 66 x 190cm absorbent area

36582001

Hip Set Intermediate

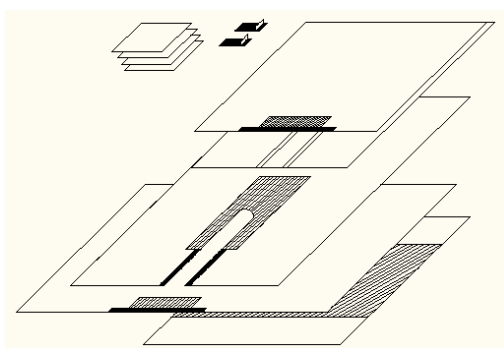

Sterile Code	Description	Size (width x Length)	Base Material
36582002	Hip Set Intermediate	-	-
-	1 x Utility drape	150cm x 175cm	3 ply laminate
-	1 x Reinforced adhesive edged drape	175cm x 300cm	3 ply laminate
-	1 x Plastic Split sheet	150cm x 200cm (split 20cm x 80cm)	Polyethylene
-	1 x Reinforced split sheet	200cm x 260cm (split 20cm x 100cm)	3 ply laminate with reinforced area
-	4 x Hand Towels	-	-
-	1 x Tape Strip	10cm x 50cm	-
-	1 x Zone reinforced trolley cover (used as sterile field)	140cm x 190cm	Polyetheylene with absorbent area 66 x 190cm

36582002

Hip Set Advanced

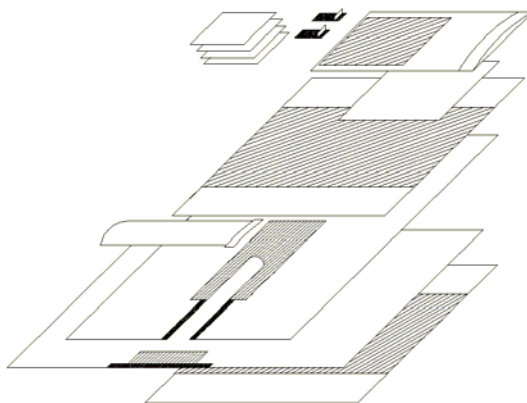

Sterile Code	Description	Size (width x Length)	Base Material
36582003	Hip Set Intermediate	-	-
-	1 x Utility drape	75cm x 90cm	2 ply laminate
-	1 x Reinforced adhesive edged drape	175cm x 300cm	3 ply laminate with absorbent area
-	1 x Reinforced split sheet	200cm x 260cm (split 20cm x 100cm)	3 ply laminate with reinforced area
-	1 x Mayo cover reinforced	76cm x 145cm	Polyethylene and reinforced area
-	4 x Hand Towels	-	-
-	1 x Stockinette Large	32cm x 120cm	2 ply laminate
-	2 x Tape Strips	10cm x 50cm	-
-	2 x Zone reinforced trolley covers (1 used as sterile field)	140cm x 190cm	Polyetheylene with absorbent area 66 x 190cm

36582003

Hip Set Elliptical

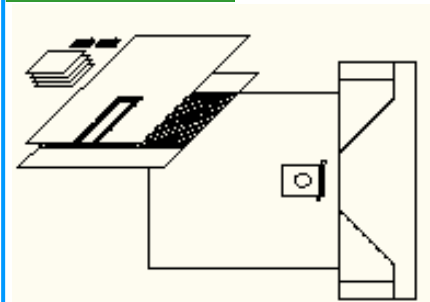

Sterile Code	Description	Size (width x Length)	Base Material
36582004	Hip Set Elliptical	-	-
-	1 x Plastic Split sheet	150cm x 200cm (split 20cm x 80cm)	Polyethylene
-	1 x Reinforced hip drape (elasticated aperture and tube holders)	300cm x 350cm (aperture 18cm x 20cm)	2 ply laminate
-	4 x Hand Towels	-	-
-	2 x Tape Strip	10cm x 50cm	-
-	1 x Zone reinforced trolley cover	140cm x 190cm	Polyetheylene with 66 x 190cm absorbent area

36582004

Extremity Set

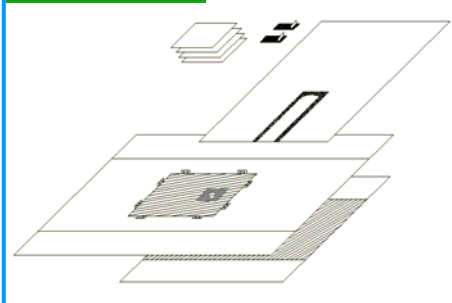

Sterile Code	Description	Size (width x Length)	Base Material
36582005	Extremity Set	-	-
-	1 x Reinforced extremity drape (elasticated aperture and tube holders)	200cm x 300cm	3 ply laminate with absorbent area 70cm x 100cm
-	2 x Hand Towels	-	-
-	2 x Tape Strips	10cm x 50cm	-
-	1 x Plastic Split sheet	150cm x 200cm (split 20cm x 80cm)	Polyethylene
-	1 x Zone reinforced trolley cover (used as sterile field)	140cm x 190cm	Polyetheylene with absorbent area 66 x 190cm

36582005

Knee Arthroscopy Set

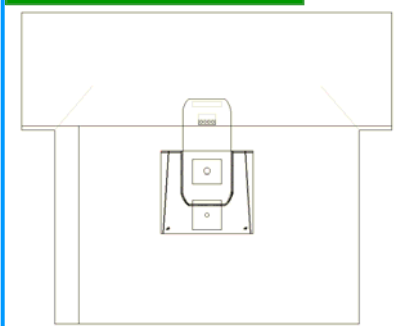

Sterile Code	Description	Size (width x Length)	Base Material
36582006	Knee Arthroscopy Set	-	-
-	1 x Arthroscopy drape with fluid collection pouch	230cm x 320cm	2 ply laminate
-	1 x Zone reinforced trolley cover (1 used as sterile field)	140cm x 190cm	Polyetheylene with absorbent area 66 x 190cm

36582006

Vertical Isolation drape

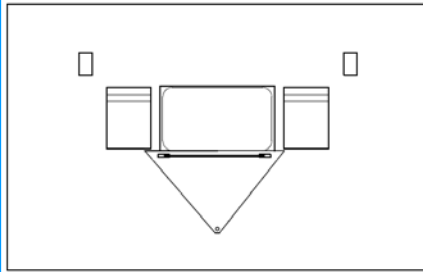

Sterile Code	Description	Size (width x Length)	Base Material
36582007	Vertical Isolation - DHS	-	-
-	1 x Vertical isolation drape with fluid collection pouch (incise 40cm x 25cm)	330cm x 240cm	Polyethylene
-	1 x CSR wrap (used as sterile field)	100cm x 100cm	Poly spun bond

36582007

Hand Drape

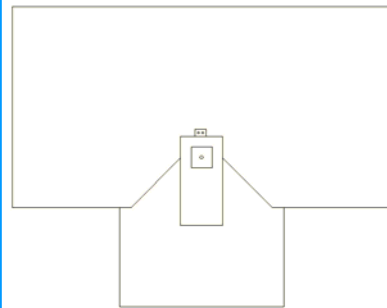

Sterile Code	Description	Size (width x Length)	Base Material
36582008	Hand Drape	-	-
-	1 x Hand drape	290cm x 361cm	SSMS
-	1 x PSB Wrap (used as sterile field)	100cm x 100cm	Poly spun bond

36582008

Bi lateral Knee Arthroscopy

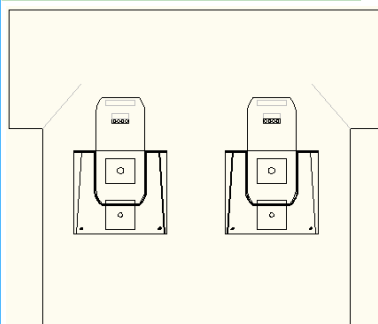

Sterile Code	Description	Size (width x Length)	Base Material
36582010	Bi-Lateral knee Arthroscopy Set	-	-
-	1 x Arthroscopy drape with 2 fluid collection pouches	230cm x 320cm	2 ply laminate
-	1 x Zone reinforced trolley cover (1 used as sterile field)	140cm x 190cm	Polyethylene with absorbent area 66 x 190cm

36582010

Foot Drape



Sterile Code	Description	Size (width x Length)	Base Material
36582011	Foot Drape (3cm diameter fenestration)	-	-
36582011	Foot Drape	193cm x 304cm	SMMS
-	1 x PSB Wrap (used as sterile field)	100cm x 100cm	Poly spun bond

36582011

Beach Chair Shoulder

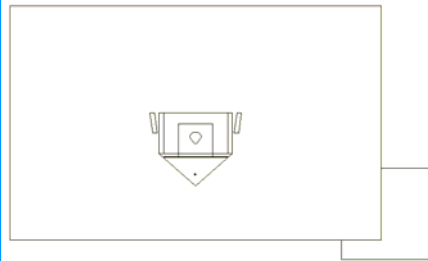

Sterile Code	Description	Size (width x Length)	Base Material
36582012	Beach Chair Shoulder Drape	-	-
-	1 x Beach chair shoulder drape	406cm x 257cm	SSMS
-	1 x PSB wrap (used as sterile field)	100cm x 100cm	Poly spun bond

36582012

Bi-Lateral Limb Sheet

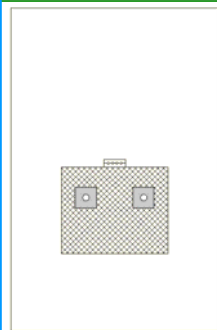

Sterile Code	Description	Size (width x Length)	Base Material
36582014	Bi-lateral Limb Sheet	-	-
-	1 x Bi-lateral Limb Sheet	194cm x 305cm	SSMS
-	1 x PSB wrap (used as sterile field)	100cm x 100cm	Poly spun bond

36582014

Tourniquet Drape



Sterile Code	Description	Size (width x Length)	Base Material
36582015	Tourniquet Drape	-	-
-	Tourniquet Drape	80cm x45.5 cm	SMMS

36582015

Extremity Foot Cover

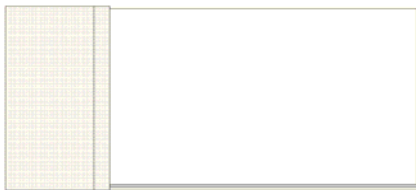

Sterile Code	Description	Size (width x Length)	Base Material
36582016	Extremity Foot Cover - Large	-	-
-	1 x Extremity Foot Cover	80cm x 35cm	SSMS
-	1 x PSB wrap (used as sterile field)	100cm x 100cm	Poly spun bond

36582016

**Vertical Isolation drape
Femoral Nailing**

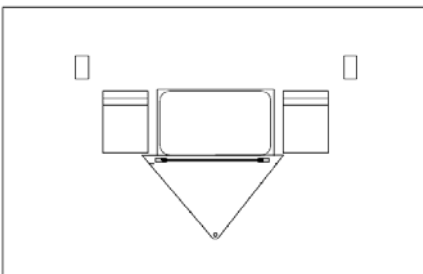

Sterile Code	Description	Size (width x Length)	Base Material
36582020	Vertical Isolation drape Femoral Nailing	-	-
-	1 X Vertical isolation drape (incise 85cm x 25cm)	240cm x 330cm	SSMMS
-	1 x PSB wrap (used as sterile field)	100cm x 100cm	Poly spun bond

36582023

**Beach Chair Shoulder Drape
With Patient Safety Window**

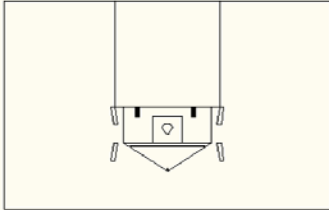

Sterile Code	Description	Size (width x Length)	Base Material
36582023	Beach Chair Shoulder Drape	-	-
-	1 X Shoulder Drape	406cm x 257cm	SSMMS
-	1 x PSB wrap (used as sterile field)	100cm x 100cm	Poly spun bond

36582023

OR DRAPES

Cardiovascular

Cardiovascular Set

Lower Vascular Drape

Cardiovascular Drape Set

Cardiovascular Set

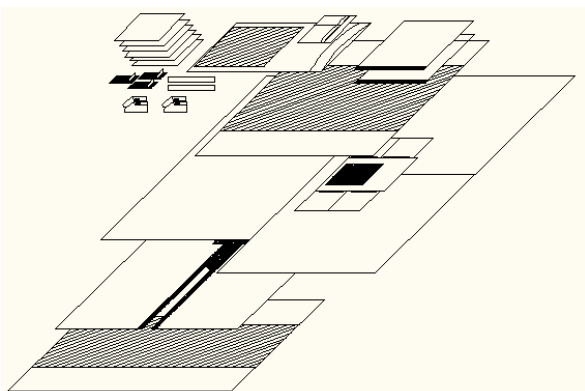

Sterile Code	Description	Size (width x Length)	Base Material
36583001	Cardiovascular Set	-	-
-	1 x Lower vascular drape	195cm x 255cm	3 ply laminate
-	1 x Thoracic drape	300cm x 330cm	2ply and 3ply laminate
-	1 x Reinforced mayo cover	76cm x 145cm	Polyethylene with reinforced area
-	6 x Hand Towels	48cm x 40cm	-
-	1 x Suction and diathermy pouch	40cm x 35cm	Polyethylene
-	2 x Velcro strips	-	-
-	3 x Tape strips	48cm x 40cm	-
-	2 x Foot covers blue	-	2ply laminate
-	2 x Foot covers clear plastic	-	Polyethylene
-	2 x Adhesive edged drapes	75cm x 75cm	3ply laminate
-	1 x Zone reinforced trolley cover	140cm x 190cm	Polyethylene with absorbent area 66 x 190cm
-	1 x Zone reinforced trolley cover (used as sterile field)	140cm x 240cm	Polyethylene with absorbent area 66 x 190cm

36583001

Lower Vascular Drape

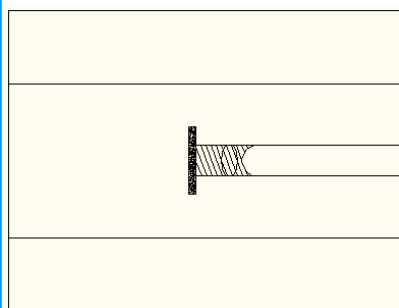

Sterile Code	Description	Size (width x Length)	Base Material
36583002	Lower Vascular drape	-	-
-	1 x Lower vascular drape	195cm x 255cm	3 ply laminate

36583002

EVAR Drape Set

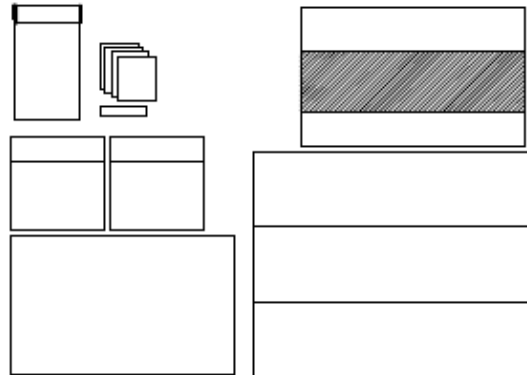

Sterile Code	Description	Size (width x Length)	Base Material
36583007	EVAR Drape Set		
	2 x Adhesive Drape with Clear Section	100 cm x 100cm	3 ply laminate Clear Polyethylene
	1 x Adhesive drape with Clear sections	295cm x 240cm	3 ply laminate Clear Polyethylene
	1 x Adhesive drape	150cm x 240cm	3 ply laminate
	4 x Hand Towels	-	-
	1 x Tape Strip	10cm x 50cm	-
	1 x Under Buttock Drape	95cm x 100cm	Clear Polyethylene
	1 x Zone reinforced trolley cover	140cm x 190cm	Polyetheylene with 66 x 190cm absorbent area

36583007

OR DRAPES

Gynaecology & Obstetrics

Gyn/Cystoscopy Set

Caesarean Section Set

Lithotomy Set

Gyn/Cystoscopy Set

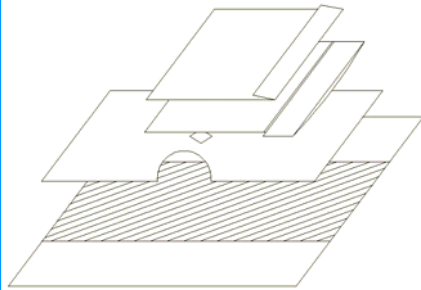

Sterile Code	Description	Size (width x Length)	Base Material
36584001	Gyn/Cystoscopy Set	-	-
-	2 x Lithotomy leggings	75cm x 100cm	2 ply laminate
-	1 x Cystoscopy drape (diamond shape fenestration)	75cm x 180cm (9cm x 15cm fen. Dim.)	2ply laminate
-	1 x Zone reinforced trolley cover (used as sterile field)	140cm x 190cm	Polyetheylene with absorbent area 66 x 190cm

36584001

Caesarean Section

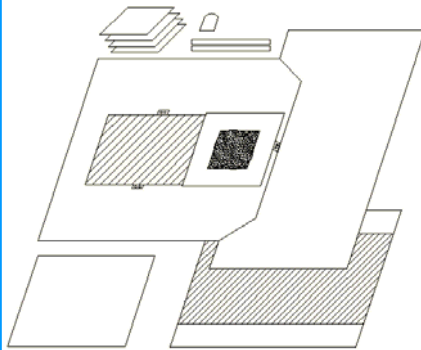

Sterile Code	Description	Size (width x Length)	Base Material
36517006	Caesarean Section Set	-	-
36517007	1 x C-section drape with full incise & fluid collection pouch	257cm x 325cm	3 ply laminate
-	1 x Baby blanket	120cm x 90cm	Cotton
-	1 x Baby hat	-	Cotton
-	2 x Velcro strips/tube holders	-	-
-	4 x Hand towels	48cm x 40cm	-
-	1 x Zone reinforced trolley cover (used as a sterile field)	140cm x 190cm	Polyethylene with absorbent area 66cm x 190cm

36517006

Caesarean Section

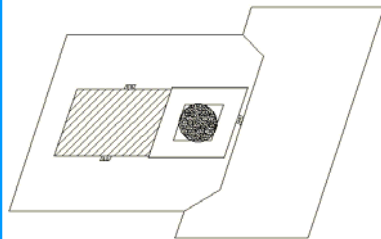

Sterile Code	Description	Size (width x Length)	Base Material
36517007	Caesarean Section Drape	-	-
36517007	1 x C-section drape with full incise & fluid collection pouch	257cm x 325cm	3 ply laminate

36517005

Caesarean Section

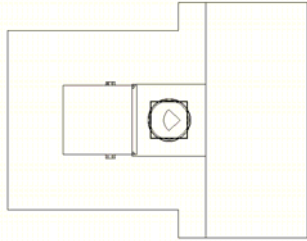

Sterile Code	Description	Size (width x Length)	Base Material
36584002	C-Section Drape with Fenestration	-	-
	1 x C-Section Drape with Fenestration	257cm x 325cm	3 ply laminate

36584002

Caesarean Section

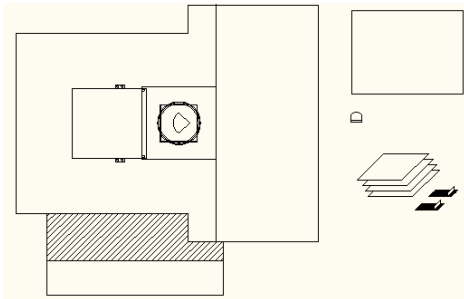

Sterile Code	Description	Size (width x Length)	Base Material
36584006	C-Section Drape with Fenestration	-	-
	1 x C-Section Drape with Fenestration	257cm x 325cm	3 ply laminate
-	1 x Baby blanket	120cm x 90cm	Cotton
-	1 x Baby hat	-	Cotton
-	2 x Velcro strips/tube holders	-	-
-	4 x Hand towels	48cm x 40cm	-
-	1 x Zone reinforced trolley cover (used as a sterile field)	140cm x 190cm	Polyethylene with absorbent area 66cm x 190cm

36584006

Lithotomy Set

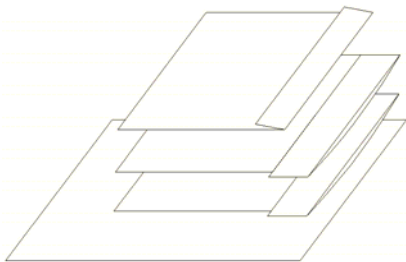

Sterile Code	Description	Size (width x Length)	Base Material
36584004	Lithotomy Set	-	-
-	2 x Lithotomy leggings	75cm x 100cm	2 ply laminate
-	1 x Under buttock drape	75cm x 100cm	2ply laminate
-	1 x Drape	90cm x 150cm	3ply laminate
-	1 x CSR wrap (used as sterile field)	75cm x 75cm	Poly spun bond

36584004

OR DRAPES

Urology

TUR Set

TUR Set

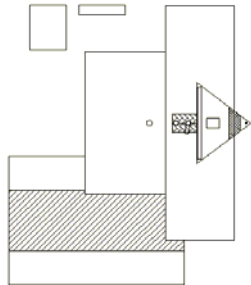

Sterile Code	Description	Size (width x Length)	Base Material
36585001	TUR Set	-	-
-	1 x TUR drape with finger cot & fluid collection pouch (6cm diameter finger cot)	255cm x 162cm	3 ply laminate
-	1 x Hand towel	48cm x 40cm	-
-	1 x Velcro strip/tube holder	-	-
-	1 x Zone reinforced table cover (used as sterile field)	140cm x 190cm	Polyethylene with absorbent area 66cm x 190cm

36585001

OR DRAPES

ENT/Head & Neck/Neuro

Craniotomy Set

Head and Neck Drape

Basic Head and Neck Set

ENT Drape Set

ENT Split Set

Craniotomy Set

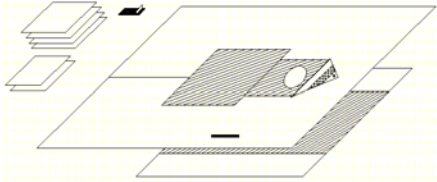

Sterile Code	Description	Size (width x Length)	Base Material
36586001	Craniotomy Set	-	-
-	1 x Reinforced craniotomy drape with fluid collection pouch	230cm x 290cm (Oval ap. 30cm wide)	3 ply laminate
-	4 x Adhesive edged drapes	50cm x 50cm	3 ply laminate
-	2 x Hand towel	48cm x 40cm	-
-	1 x Tape strip	-	-
-	1 x Zone reinforced table cover (used as sterile field)	140cm x 190cm	Polyethylene with absorbent area 66cm x 190cm

36586001

Head and Neck Drape

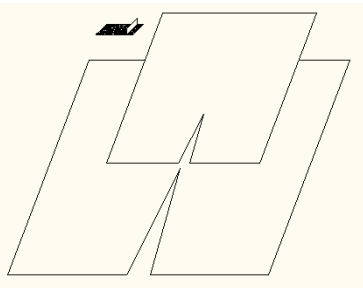

Sterile Code	Description	Size (width x Length)	Base Material
36586002	Head and Neck Drape	-	-
-	1 x Drape (35cm long split)	100cm x 105cm	SMS
-	1 x Head drape (75cm long split)	170cm x 150cm	3 ply laminate
-	1 x Tape strip	10cm x 50cm	-
-	1 x CSR drape (used as sterile field)	75cm x 75cm	Poly spun bond

36586002

Head and Neck Set

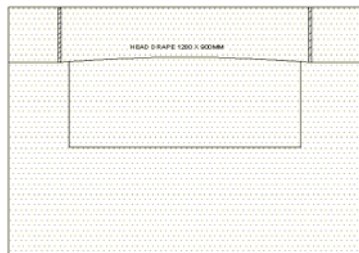

Sterile Code	Description	Size (width x Length)	Base Material
36586003	Basic Head and Neck Set	-	-
-	1 x Head drape	128cm x 90cm	SMMS

36586003

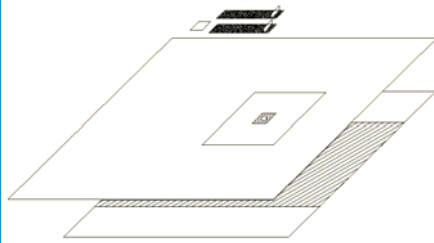
ENT Drape Set

Sterile Code	Description	Size (width x Length)	Base Material
36586004	ENT Drape Set	-	-
-	1 x ENT drape (9cm diameter aperture)	224cm x 180cm	SMMS with absorbent area 62cm x 60cm
-	2 x Adhesive Tape strips	-	-
-	1 x Zone reinforced table cover (used to wrap the set)	140cm x 190cm	Polyethylene with absorbent area 66cm x 190cm
-	1 x CSR drape (used as sterile field)	100cm x 100cm	Poly spun bond

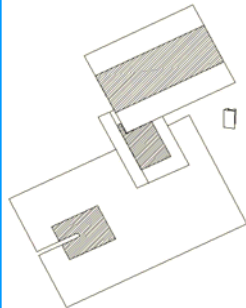
36586004
ENT Split Set without Mayo

Sterile Code	Description	Size (width x Length)	Base Material
36586006	ENT Split Set without Mayo	-	-
-	1 x Head Drape	128cm x 90cm	SMMS
-	1 x paper bag	17cm x 29cm	Paper
-	1 x reinforced split drape (72cm split - 7cm wide)	195cm x 315cm (split 7cm x 72cm)	SMMS
-	1 x Zone reinforced table cover (used to wrap the set)	140cm x 190cm	Polyethylene with absorbent area 66cm x 190cm

36586006

OR DRAPES

Supplementaries

Utility Drapes

Trolley Cover

Adhesive Drapes

Aperture Drapes

Mayo Covers

Split Sheets

Lithotomy Leggings

Stockinettes

Miscellaneous

Utility Drapes

Sterile code	36589011
Description	Utility drape
Size (width x length)	50cm x 60cm
Base Material	2 ply laminate

Sterile code	36589012
Description	Utility drape
Size (width x length)	75cm x 90cm
Base Material	2 ply laminate

Sterile code	36589014
Description	Utility drape
Size (width x length)	45cm x 75cm
Base Material	3 ply laminate

Sterile code	36589015
Description	Utility drape
Size (width x length)	75cm x 90cm
Base Material	3 ply laminate

Trolley Covers

Sterile code	36589004
Description	Trolley cover
Size (width x length)	100cm x 140cm
Base Material	Polyethylene with absorbent area 66cm x 100cm

Sterile code	36589005
Description	Trolley cover
Size (width x length)	140cm x 140cm
Base Material	Polyethylene with absorbent area 66cm x 140cm

Sterile code	36589006
Description	Trolley cover
Size (width x length)	190cm x 140cm
Base Material	Polyethylene with absorbent area 66cm x 190cm

Sterile code	36589007
Description	Trolley cover
Size (width x length)	210cm x 140cm
Base Material	Polyethylene with absorbent area 66cm x 210cm



Adhesive Drapes

Sterile code	36589016
Description	Adhesive drape reinforced
Size (width x length)	75cm x 90cm
Base Material	3 ply laminate

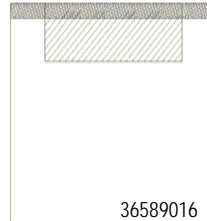

Sterile code	36589019
Description	Adhesive drape
Size (width x length)	75cm x 75cm
Base Material	3 ply laminate

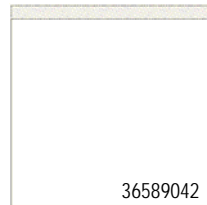

Sterile code	36589021
Description	Utility drape
Size (width x length)	75cm x 90cm
Base Material	3 ply laminate

Sterile code	36589022
Description	Utility drape
Size (width x length)	100cm x 100cm
Base Material	3 ply laminate

Sterile code	36589034
Description	Adhesive drape reinforced
Size (width x length)	150cm x 240cm
Base Material	3 ply laminate

Non sterile code	89035
Sterile code	36589035
Description	Adhesive drape
Size (width x length)	175cm x 175cm
Base Material	3 ply laminate

Adhesive Drapes

Non sterile code	89036
Sterile code	36589036
Description	Adhesive drape Reinforced
Size (width x length)	150cm x 240cm
Base Material	2 ply laminate

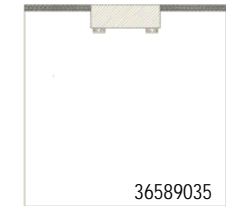

Non sterile code	89037
Sterile code	36589037
Description	Adhesive drape
Size (width x length)	150cm x 175cm
Base Material	2 ply laminate



Aperture Drapes

Sterile code	36589024
Description	Aperture drape with adhesive
Size (width x length)	75cm x 90cm (ap. 6 x 8cm)
Base Material	2 ply laminate



Sterile code	36589025
Description	Aperture drape with adhesive
Size (width x length)	50cm x 60cm (ap. 6 x 8cm)
Base Material	2 ply laminate

Sterile code	36589026
Description	Aperture drape with adhesive
Size (width x length)	60cm x 75cm (ap. 10 x 6cm)
Base Material	2 ply laminate

Sterile code	36589027
Description	Aperture drape with adhesive
Size (width x length)	100cm x 125cm (ap. 11cm circular)
Base Material	2 ply laminate

Sterile code	36589051
Description	Aperture drape with adhesive
Size (width x length)	150cm x 175cm (ap. 15cm circular)
Base Material	2 ply laminate

Mayo Covers

Sterile code	36589008
Description	Mayo stand cover reinforced
Size (width x length)	76cm x 145cm
Base Material	Polyethylene with reinforced area



Sterile code	36589042
Description	Mayo stand cover standard
Size (width x length)	76cm x 145cm
Base Material	Polyethylene

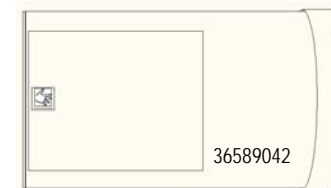

Split Sheets

Sterile code	36589031
Description	Plastic split sheet
Size (width x length)	150cm x 200cm (split 20cm x 80cm)
Base Material	Polyethylene

Sterile code	36589032
Description	Reinforced split sheet
Size (width x length)	200cm x 260cm (20cm x 100cm split)
Base Material	3 ply laminate with reinforced area

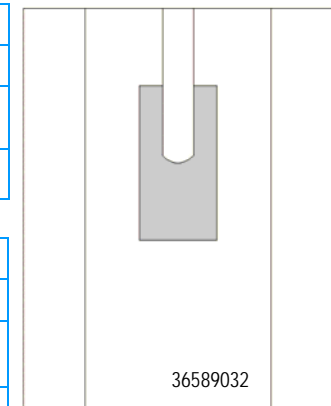

Lithotomy Leggings

Sterile code	36589001
Description	Lithotomy leggings (2 pieces)
Size (width x length)	75cm x 120cm
Base Material	2ply laminate



Sterile code	36589062
Description	Transparent Lithotomy leggings (2 pieces)
Size (width x length)	75cm x 120cm
Base Material	Polyethylene film

Miscellaneous Drapes

Sterile code	36589029
Description	Suction & diathermy pouch
Size (width x length)	40cm x 35cm
Base Material	Polyethylene

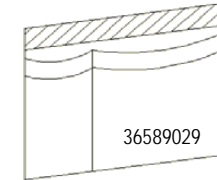

Sterile code	36589040
Description	Irrigation pouch
Size (width x length)	52cm x 52cm
Base Material	Polyethylene

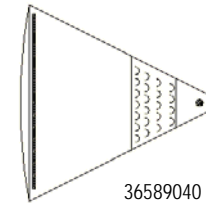

Stockinettes

Sterile code	36589010
Description	Stockinette large
Size (width x length)	32cm x 120cm
Base Material	2ply laminate

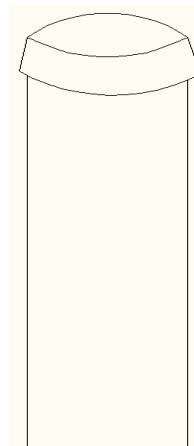

Miscellaneous

Sterile code	36589041
Description	Adhesive OP-Tape
Size (width x length)	10cm x 50cm
Base Material	Non woven and adhesive



Under Buttock Drapes

Sterile code	36589028
Description	Under Buttock drape with port and fluid loss marker
Size (width x length)	100cm x 110cm
Base Material	2ply laminate

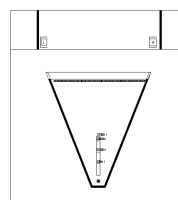

Sterile code	36589039
Description	Under Buttock drape
Size (width x length)	85cm x108 cm
Base Material	2ply laminate

